



Philadelphia Hardware Group, Inc.

6590 Top Gun St.
 San Diego, CA 92121
 www.philhardware.com
 Tel: 858-642-0450
 Fax: 858-642-0454
 V052623

Advantage Exit Device 70/71 Series

ANSI GRADE 1
 ANS/BHMA A156.3-2001
 Type 1 & Type 2
 Exceeds 500,000 Cycles



LISTED

UL Listed for "A" Label Doors
 Rated Up to 3 Hours
 UL10C Positive Pressure Rated
 Conforms to UBC 7-2 (1997)
 UL305 Listed for Panic Hardware
 UL10B Neutral Pressure Rated



Comply with
 ANSI117.1 for
 Accessible and
 Usable Buildings
 and Facilities
 Standards



Specifications

Certification	ANSI Grade 1 Approved, Exceeds 500,000 Cycles UL305 Listed for Panic Hardware UL Listed for Up To 3HRS on "A" Label Fire Door UL10B Neutral Pressure Rated UL10C/UBC7-2(1997) Positive Pressure Rated Comply with ANSI117.1 for Accessible and Usable Buildings and Facilities Standards
Door Fitting	1-3/4" Door Thickness Rim – 4-1/2" Minimum Stile Width for Single Door with 5/8" Stop SVR – 4-1/2" Minimum Stile Width for Single Door with Outside Trim 3-1/2" Minimum Stile Width for Single Door without Outside Trim
Door Width	36" – Rail Can Be Cut From The End To Fit Door Size Down To 30" 48" – Rail Can Be Cut From The End To Fit Door Size Down To 40"
Door Height	84" – Standard With 36" Device 96" – Standard With 48" Device ETR12 – Can Be Use to Extend Height
Structure	Head Cover – Plated Zinc Alloy Chassis – Steel Or Stainless Steel End Cap – Plated Zinc Alloy Rail Assembly – Heavy Gauge Steel Or Stainless Steel
Latch Bolt	Rim – 3/4" Throw, Automatic Dead-Latching By Pressing The Guard Bolt SVR – 1/2" Throw
Strike	Rim – 9170S Standard Rim Strike 9171 – 1/8" Thick Shim for 9170S Strike 9167 – 2-3/8" Backset Strike SVR – Top: SVRTS72 Standard Top Strike Bottom: SVRBS73 Standard Bottom Strike SVRABS74 Alternative Bottom Strike SVRCBS75 Alternative Mortise In Bottom Strike 9285 Overlapping Strike with 1/8" Shim For Use With Rim Exit Device with SVR Exit Device

SAN DIEGO

CHICAGO

ATLANTA

DALLAS



6590 Top Gun St.
 San Diego, CA 92121
 www.philhardware.com
 Tel: 858-642-0450
 Fax: 858-642-0454
 V052623

Philadelphia Hardware Group, Inc.

Fastener	Furnished with Wood Screws and Machine Screws Sex Bolts (Fire Rated Device) 1346 – For 1-3/4" ~ 2" Door – Rim Exit Device (6 Pcs / Pack) 1314 – For 1-3/4" ~ 2" Door – SVR Exit Device (14 Pcs / Pack) 2146 – For 2-1/4" Door – Rim Exit Device (6 Pcs / Pack) 2116 – For 2-1/4" Door – SVR Exit Device (14 Pcs / Pack)
Filler	9222 – 1-1/8" x 2-1/4" Latch Front Filler 9209 – 1-1/4" x 4-7/8" ASA Strike Filler
Handing	Rim – Reversible, Non Handed SVR – Standard with LHR or RHR, Easily Field Reversible
Dogging	Standard for 7000 / 7100 (Non Rated) Cylinder Dogging Kit Available: - 78CDK36 = 36" - 78CDK48 = 48"
Alarm Kit	78AK36 = 36" 78AK48 = 48"
Finishes (BHMA)	US32D (630), ALUM (689), DURO (695), US19 (622)

Dimensions

Rim Exit Device:

Projection: 2-1/2" Maximum
 Overall Size: 6" Height x 32" x 44" Width

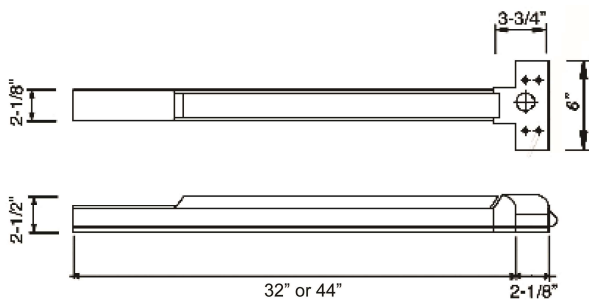

SVR Exit Device:

Projection: 2-1/2" Maximum
 Overall Size: 6" Height x 32" or 44" Width
 Top Latch Case: 4" Height x 2-1/8" Width
 Bottom Latch Case: 4" Height x 2-1/8" Width
 Latch Bolt: 1/2" Throw

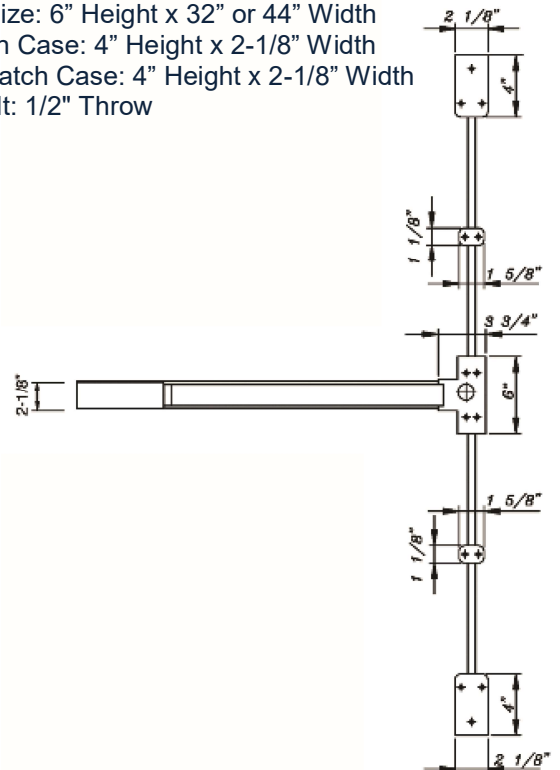

Functions

- 70ED36R – 36" Rim
- 70ED48R – 48" Rim
- 70ED36FR – 36" Fire Rated Rim
- 70ED48FR – 48" Fire Rated Rim
- 71ED3684SVR – 36" x 84" SVR
- 71ED4896SVR – 48" x 96" SVR
- 71ED3684FSVR – 36" x 84" Fire Rated SVR
- 71ED4896FSVR – 48" x 96" Fire Rated SVR
- 71ED36FLBR – 36" Fire Rated LBR
- 71ED48FLBR – 48" Fire Rated LBR

SAN DIEGO

CHICAGO

ATLANTA









DALLAS

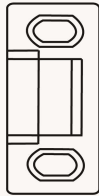
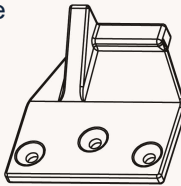

6590 Top Gun St.
 San Diego, CA 92121
 www.philhardware.com
 Tel: 858-642-0450
 Fax: 858-642-0454
 V052623

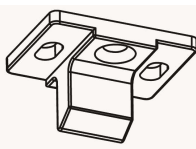
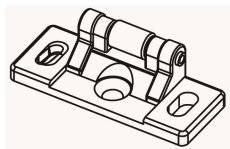
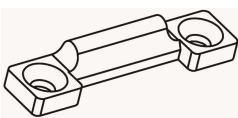
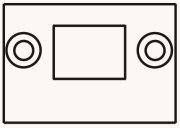
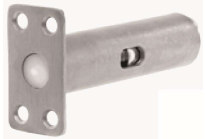
Philadelphia Hardware Group, Inc.

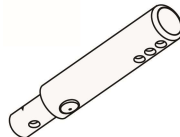
Accessories

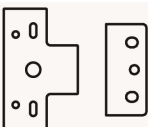
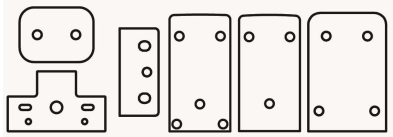
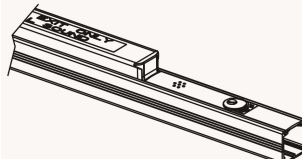
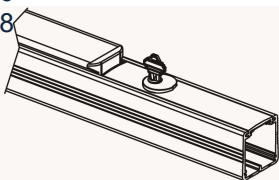
<p>9170S Rim Strike</p> 	<p>9171 Shim</p> 	<p>9167 2-3/8" Rim Strike</p> 	<p>9285 Overlapping Strike</p> 	<p>9222 Latch Front Filler</p> 
<p>9209 ASA Strike Filler</p> 	<p>SVRTS72 Top Strike</p> 	<p>SVRBS73 Bottom Strike</p> 	<p>SVRABS74 Alternative Bottom Strike</p> 	<p>SVRCBS75 Mortise In Bottom Strike</p> 
<p>AFL9279 Aux Fire Latch</p> 	<p>Sex Bolts</p> 	<p>ETR12 12" Extension</p> 	<p>9201-78 Dogging Key</p> 	<p>1001 Glass Bead Shim Kit - Rim</p> 
<p>1006 Glass Bead Shim Kit - SVR</p> 		<p>78AK36 78AK48 Alarm Kit</p> 	<p>78CD36 78CD48</p> 	

SAN DIEGO

•

CHICAGO

•

ATLANTA

•

DALLAS