

E Series

ES CYLINDRICAL LEVERSET (CLUTCH)

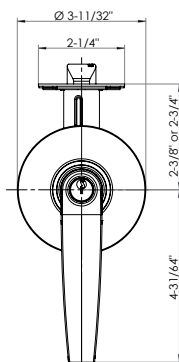

500ES-CT
Charlotte (CT) Lever

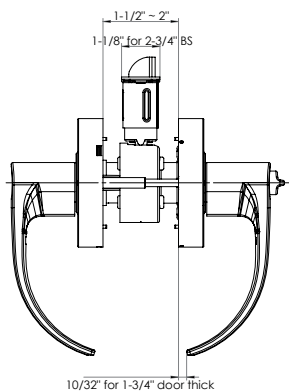
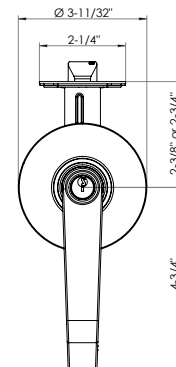
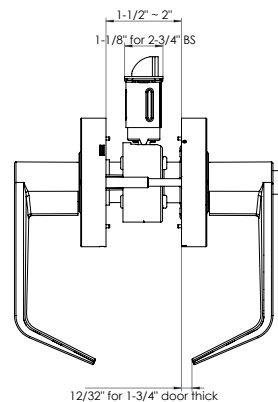

500ES-SD
San Diego (SD) Lever



500ES-MD
Madison (MD) Lever

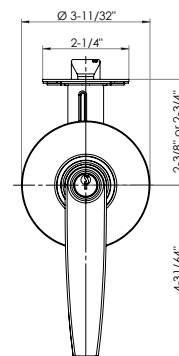
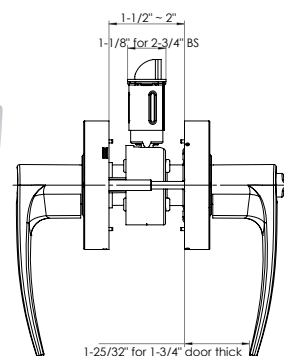

Features

- SC4 6-pin Standard
- Independent Torsion Spring
- Fast and Easy Installation
- Clutch Function Standard
- Removable Through Bolt, 2-3/4" CTC
- Panic Proof (inside always free)
- Concealed Mounting Screws

ES: Lock with standard cylinder or no cylinder

ESIC: Lock with interchangeable core design

ANSI GRADE 2 CLUTCH ES/ESIC

LIFETIME Warranty

ANSI GRADE 2
ANSI/BHMA A156.2-2011
Series 4000, Grade 2
Exceeds 400,000 Cycles



3 Hours Fire Rating
UL10C/
UBC 7-2(1997)
Positive Pressure
LISTED Rated



ADA Compliant
ANSI A117.1
Barrier Free
Accessibility



NOA No. 15-0629.03 +/- 90 PSF
Florida Building Code: 20485

**CALIFORNIA STATE
REFERENCE CODE**
Formerly Title 19, California
State Fire Marshal (CSFM)

levers return to within
1/2" of door face
(CT & SD Lever Only)

Specifications

Door Fitting	1-1/2" ~ 2" door standard. Factory preset at 1-3/4". Thru-Bolt CTC: 2-3/4".
Exposed Trim	Wrought brass. Pressure cast zinc lever.
Lock Chassis	Heavy gauge dichromated steel. Featuring a solid zinc rosette, both interior and exterior for extra security.
Cylinder	Solid brass SC4 6-pins standard. KW1 5-pins optional.
Latch	1/2" throw stainless steel latch bolt. Square corner faceplate standard, round corner available. 2-3/4" backset: 1-1/8" x 2-1/4" faceplate. Optional for 1" width. 2-3/8" backset: 1" x 2-1/4" faceplate. Foating latch design fits both flat or beveled doors 1/8" in 2" Backset: 2-3/4" stanard, optional for 2-3/8", 3-3/4" & 5".
Strike	ASA Strike standard (9109).
Handing	Universal, non-handing.
Screws	Combination screws for both metal and wood doors.
Keys	2 brass keys per set. Key as requested (KA, KD, MCK, MK, GMK).
IC Core	ESIC, e.g. 500ESIC for Entrance. SFIC compatible with BEST profile 6-pins and 7-pins.

Removable Through Bolt

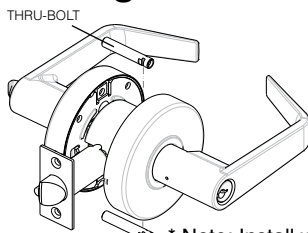

* Note: Install w/o thru-bolts void ANSI Grade 2, and warranty.

Floating Latch Design

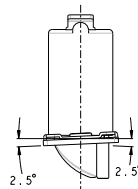

Adjustable for flat or beveled doors 1/8" in 2"

Door Preparation

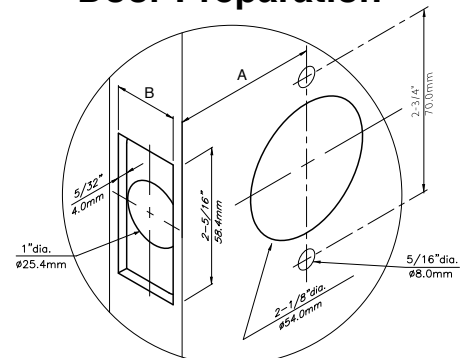

Latch & Parts



E9060T S
Dead Latch for 2-3/8" backset
E9070T S
Dead Latch for 2-3/4" backset



E9068T S
Spring Latch for 2-3/8" backset
E9078T S
Spring Latch for 2-3/4" backset



1180
Faceplate Adapter
Use on 1" width for 1-1/8" width requirement

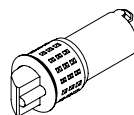

E9060C
Drive-in Dead. Latch for 2-3/8" backset
E9070C
Drive-in Dead. Latch for 2-3/4" backset

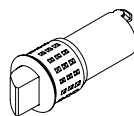

E9068C
Drive-in Spring. Latch for 2-3/8" backset
E9078C
Drive-in Spring. Latch for 2-3/4" backset

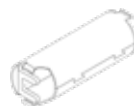

2214
5" backset extension tube (use with 2-3/4" backset latch)
2138
3-3/4" backset extension tube (use with 2-3/8" backset latch)

Backset	2-3/4"	2-3/8"
A	2-3/4"	2-3/8"
B	1-3/16"	1-1/16"

Strike



9109 ASA Strike
1-1/4" x 4-7/8",
5/8" lip

9106 T-Strike
1-1/8" x 2-3/4"



ES-50
Electric Strike

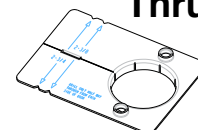

9234
2-3/8" or 2-3/4" backset
Vertical CTC 2-3/4"